

Coffee System

TANGO ACESELF, 1 group full-automatic machine

ITEM # _____

MODEL # _____

NAME # _____

SIS # _____

AIA # _____



602557 (TANGOACEISELF) Full-automatic machine, 1 group, 220x40 ml espresso cup/hr, 6,5 liter steam/coffee boiler, 1x1,7 kg and 1x1,2 kg coffee hopper, hot water

Short Form Specification

Item No.

The Tango® ACE fully takes advantage of the reliability, usability and exceptional extraction quality that has established the reputation of the TANGO® range.

In its Self version, the Tango® ACE comes with lockers for bean hoppers and waste coffee drawer, it has no steam outlet neither ground coffee box for security reason. The Tango® ACE Self version is ideal for using in all self-service areas with its self-explanatory 7" color touch screen user interface easy to use.

With the addition of the Cappuccinatore device, the Tango® ACE Self offers the choice of fresh milk-based beverages at the push of a button.

Main Features

- 1 group full-automatic machine with self service configuration.
- 6.5 liter steam/coffee boiler.
- Auto cleaning program.
- In its Self version, the Tango® ACE comes with lockers for bean hoppers and waste coffee drawer, it has no steam outlet neither ground coffee box for security reason. The Tango® ACE Self version is ideal for using in all self-service areas with its self-explanatory 7" color touch screen user interface easy to use.
- Programmable hot water.
- The Tango® ACE fully takes advantage of the reliability, usability and exceptional extraction quality that has established the reputation of the TANGO® range.

Construction

- 2 coffee grinders (1 x 1,7 kg & 1 x 1,2 kg coffee hoppers).
- LCD Touchscreen.
- PID (proportional-integral-derivative) Temperature control: a precise controller algorithm system that gives consistency and accuracy to brewing temperature management system.
- Safety locks.

Optional Accessories

- Side milk refrigerator 8 liter nominal capacity for up to 4 liter milk containers PNC 871014
- Side milk refrigerator 8 liter nominal capacity for up to 4 liter milk containers with digital display PNC 871015
- TANGO hotel/breakfast service kit PNC 871022
- Coffee ground direct discharge chute PNC 871023
- Raised feet kit PNC 871041

APPROVAL: _____

Front



Side

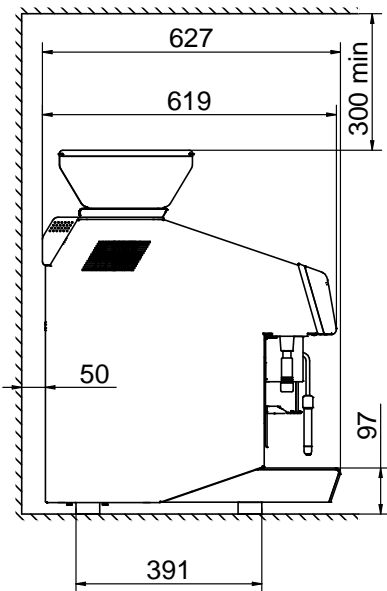

Top

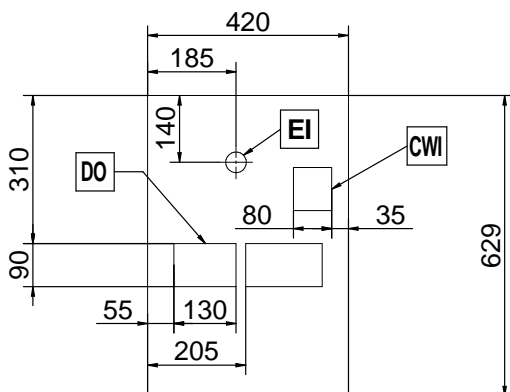

Electric

Supply voltage:

602557 (TANGOACE1SELF) 400 V/3N ph/50 Hz

Electrical power max.: 5.2 kW

Plug type: Cable without plug

Water:

Cold water temperature

(min/max): 5 / 60 °C

Key Information:

External dimensions, Width: 448 mm

External dimensions, Depth: 627 mm

External dimensions, Height: 846 mm

Net weight: 103 kg

Shipping volume: 0.7 m³

Sustainability

Current consumption: 7.5 Amps